



*Gazebo-works*  
*Too, Incorporated*  
"Where Quality Comes First"

P.O. Box 5257  
Central Point, OR 97502  
[www.gazeboworkstoo.com](http://www.gazeboworkstoo.com)  
[info@gazeboworkstoo.com](mailto:info@gazeboworkstoo.com)

(888) 367-7920 Toll Free  
(541) 664-2000  
(541) 664-6189 Fax

Customer Service  
Monday - Friday  
8:00 AM - 5:00 PM PST

# Free Standing

## Assembly Instructions

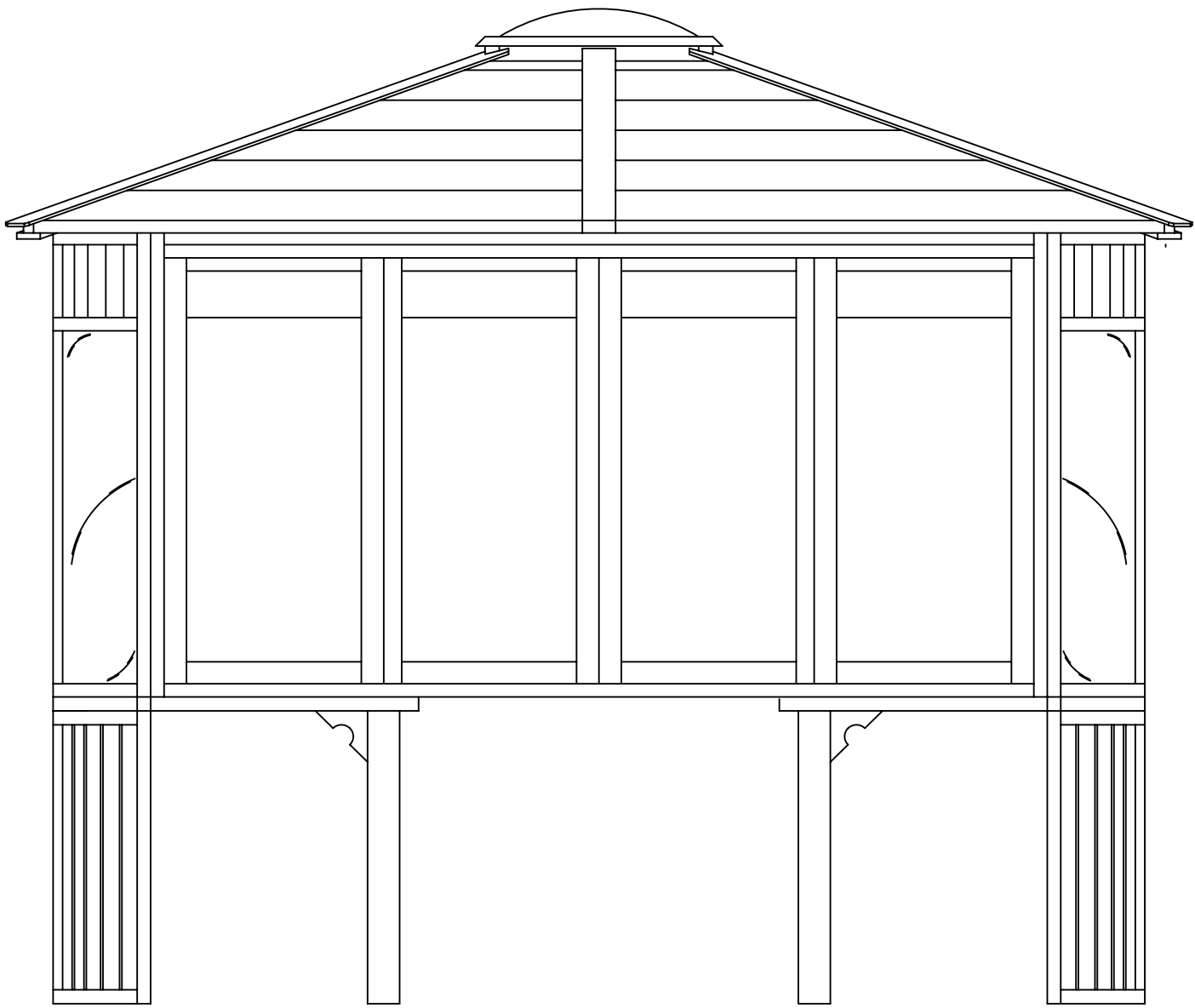

# Free Standing

---

---

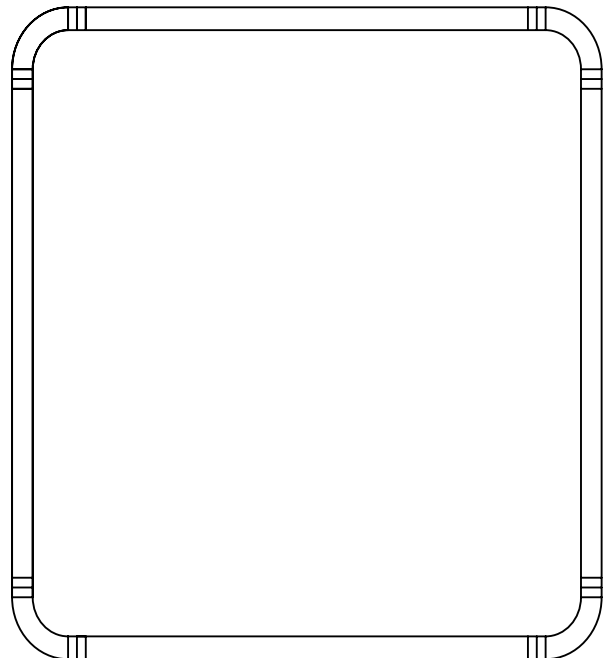
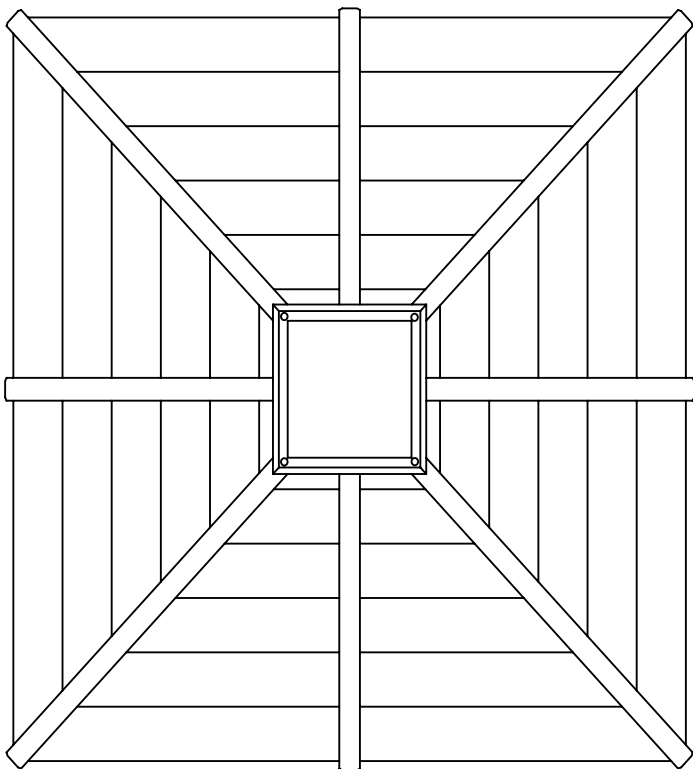
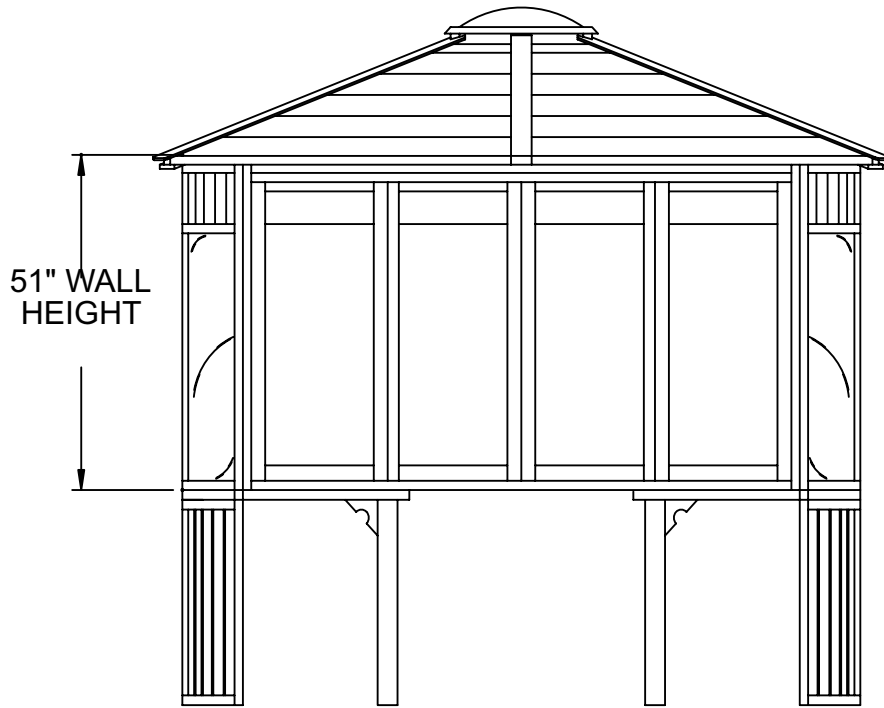

# Gazebo Works Too

*Congratulations on your purchase of a quality redwood spa surround from Gazebo Works Too. We believe it will offer you many years of value, comfort, and privacy.*

Before you get started please take a minute to familiarize yourself with the entire installation procedure by reading the parts list and following the assembly instructions from beginning to end, so that you understand what will be involved in properly assembling your surround.

You will require the following equipment and tools:

- Six or eight foot step ladder
- Electric screw driver/drill
- Carpenter's tape measure (20' or longer)
- Phillips head screw driver
- Slotted head screw driver
- A hammer

Note: *Two people are needed to safely assemble this product.*

## Maintenance after installation

Wash all corner windows and domes with a soft cloth using a mixture of mild detergent and water. Some commercial window cleaners are acceptable but DO NOT use any products that contain, ammonia, alcohol, or petroleum distillates as they can damage the surfaces.

Periodically, clean leaves and other debris from the roof as it can discolor the surface and may lead to leaks in some areas. Do not allow standing water to pool next to any wood surface and always remove accumulations of snow and ice on the roof and around the walls.

After one to two years you may need to apply another coat of stain in order to preserve the water resistant finish on the exterior surfaces of your enclosure. Be sure to clean the wood first using a commercial cleaning solution.

# Free Standing

Manufacturer recommends assembly on a solid flat surface: cement or deck.  
 Manufacturer recommends attaching this unit to this surface.

## Parts Inventory

The window-acrylic and the corner-Lexan have a protective sheet on both sides -  
 PEEL THIS OFF.

3 Walls

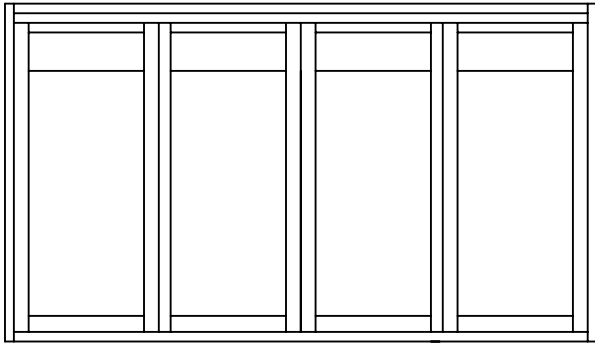

2-4x4 Entry Posts

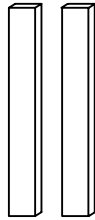

4 Freestanding Corners



Top Plate Assembly

4 Crosses

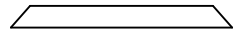

4 Centers

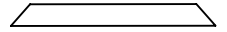

8 Corners

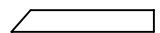

1 Entry Wall

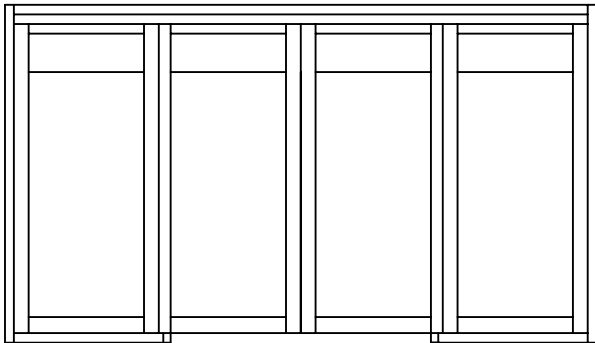

1 Dome Box

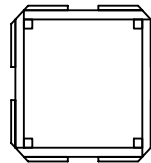

1 Dome

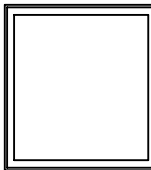

4 Common Rafters

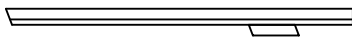

4 Hip Rafters

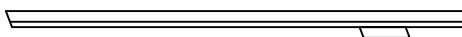

4 Common Wall Blocks



4 Hip Rafter Caps

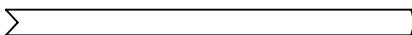

4 Common Rafter Caps

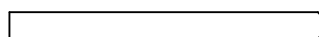

Roof Panels

4 Left

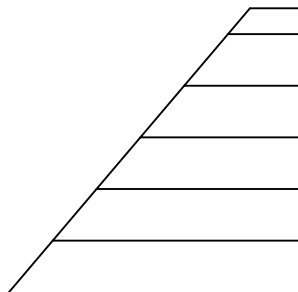

4 Right

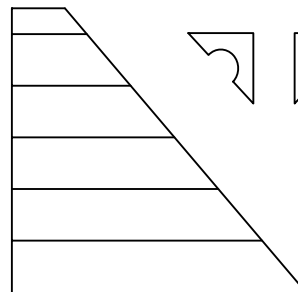

2 Entry Corbels



For Deluxe Metal Roofs

4 Hip Cap Ends



1 Hardware Package

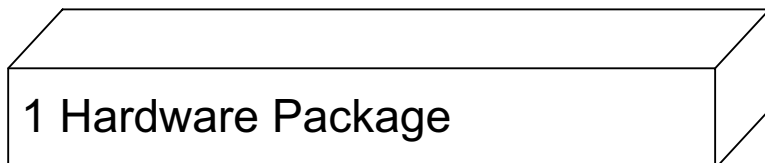

### Pack Contents:

- 8 Alignment Pins
- 4 Silver Dome Screws and Washers
- 1 Pkg. 2 1/2" Zinc Screws
- 1 Can of Stain
- 3 Sets of Window Latches

## Step 1

Place a wall on a flat surface with the interior side up. Use the 4x4 entry posts as a guide for the freestanding corner location only. Secure corners to the wall. Repeat process for a second wall.

(See Example 2-1)

Use three(3) 2 1/2"  
Screws per side.

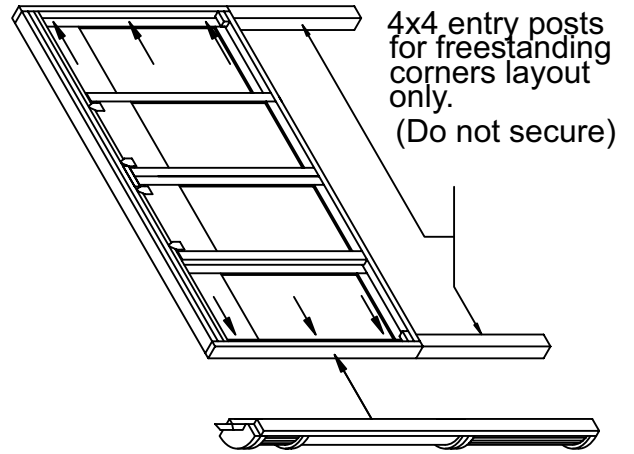
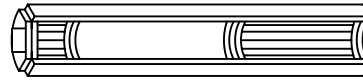

**Example 2-1**

## Step 2

Stand the two completed walls upright with the interiors facing each other. Slide the third wall between them, again using the 4x4 entry posts as a guide and support. Secure the wall as in Step 1.

(See Example 2-2)

(3) 2 1/2"  
screws through  
side frame  
into the  
lip-mount corner

6 Screws

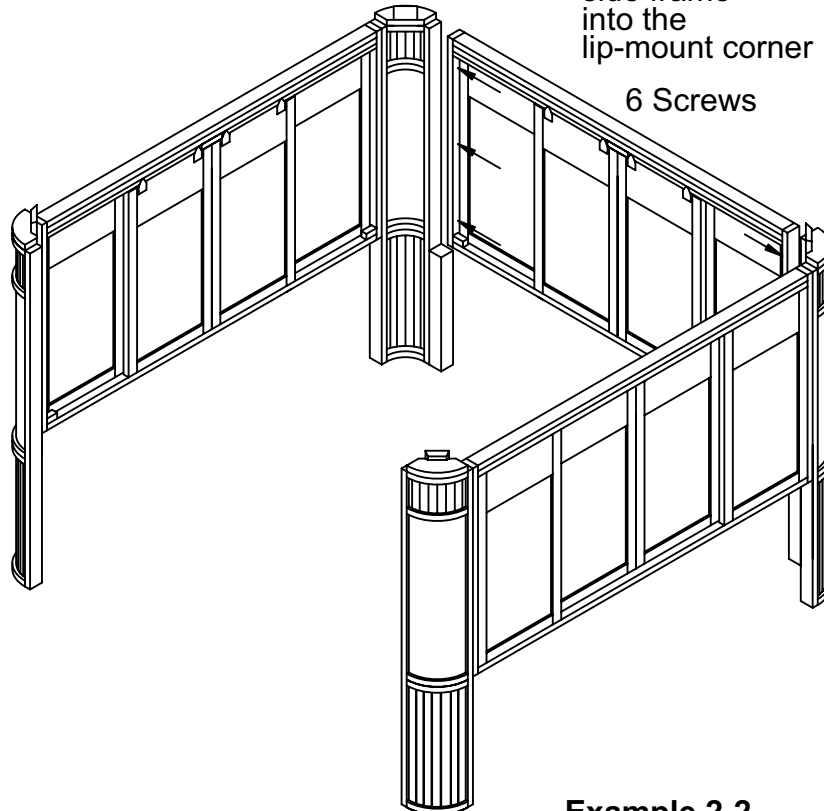

**Example 2-2**

### Step 3

Slide the entry wall between the two corners. Again, use the 4x4 entry posts as supports at the wall ends. Secure as in Step 1. (See Example 3-1)

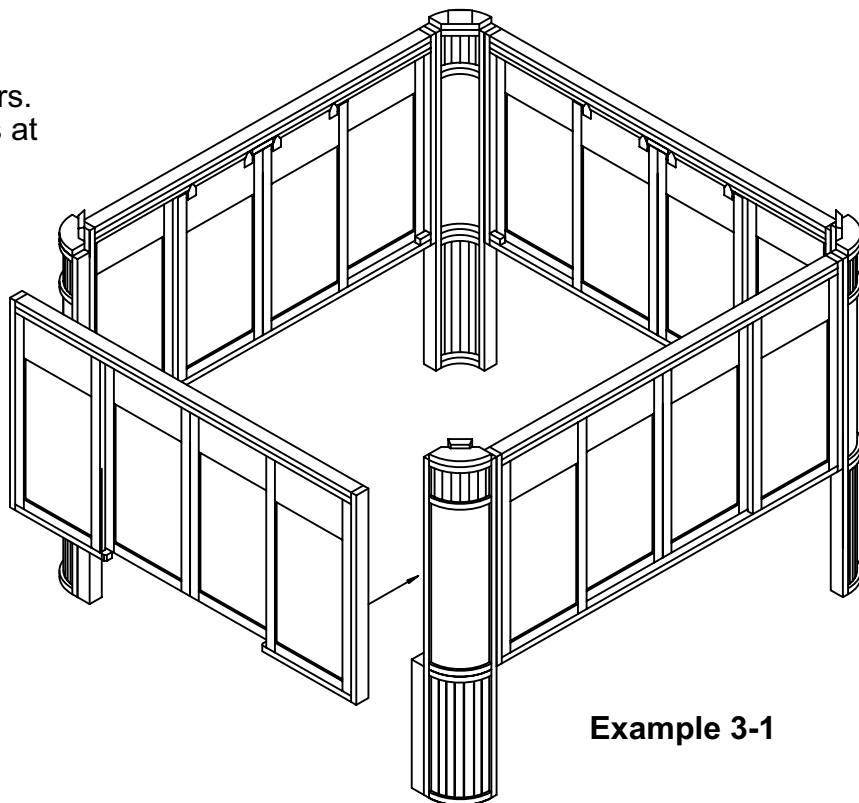

**Example 3-1**

### Step 4

Slide the 4x4 entry posts to the edge of the bottom framework. Secure in place with (3) 2-1/2" screws each down through the wall framework into the posts. Place the entry corbels as shown and secure to the framework using the pre-drilled holes in the corbels.

(See Example 3-2)

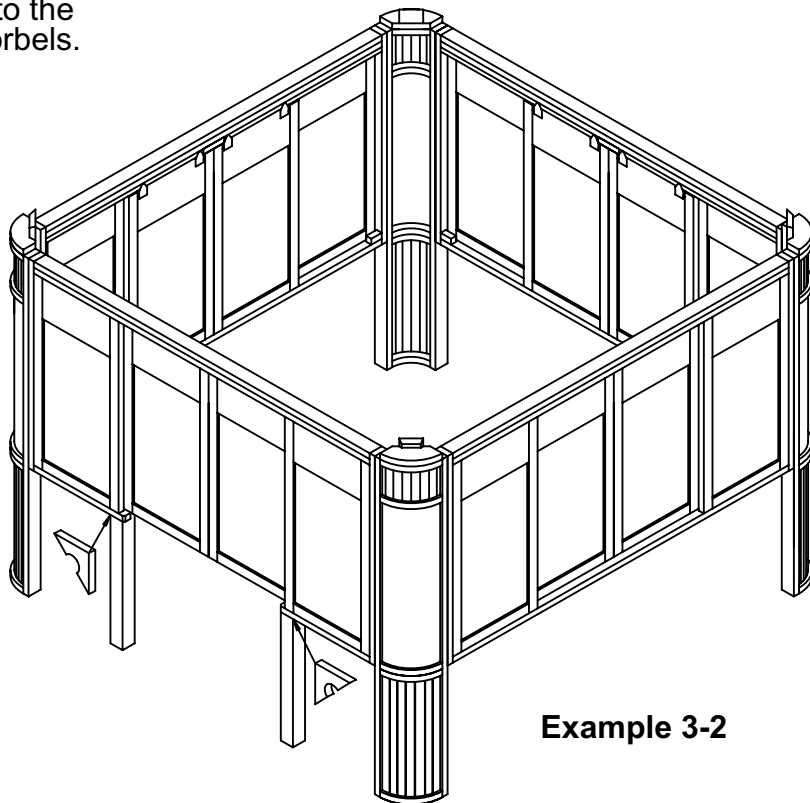

**Example 3-2**

## Step 5

Before installing the top plate, measure diagonally across the freestanding round corners to ensure that the gazebo is square. A-C should be the same as B-D. Move wall sections as needed until there is less than 1/4" difference between the two measurements.

(See Example 4-1)

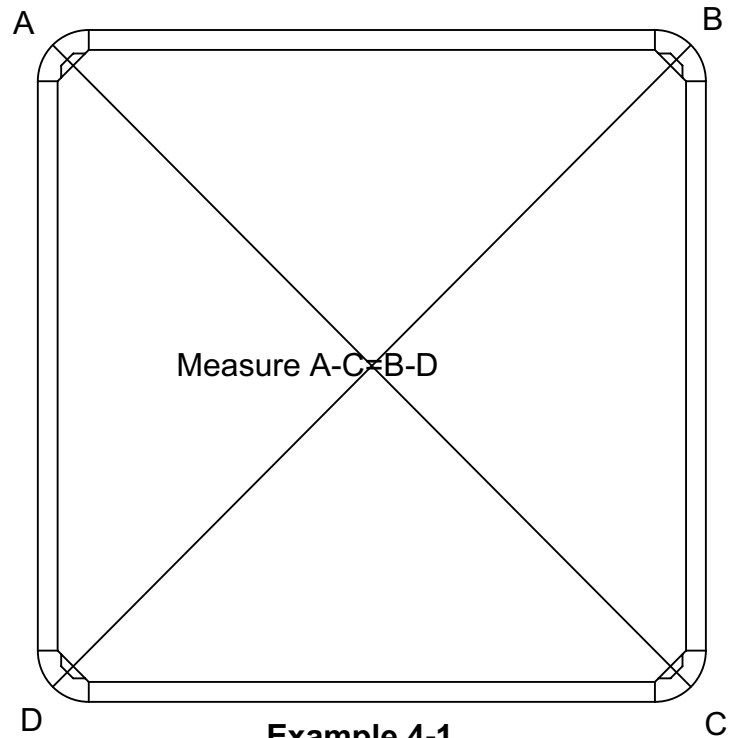

## Step 6

Secure the top plates to the top of the corner/wall sections with six(6) 2 1/2" screws per plate, through the topplate into the corner/wall sections. Topplates should be flush with exterior side of the wall sections. See Detail E-E 1. In addition, screw down on either side where wall sections meet. See Detail E-E 2.

(See Example 4-2)

Two screws go into the corner topplates into the 2x4 side frames of the round corners and two more screws 4-6" further back. Put two more screws at the other end.

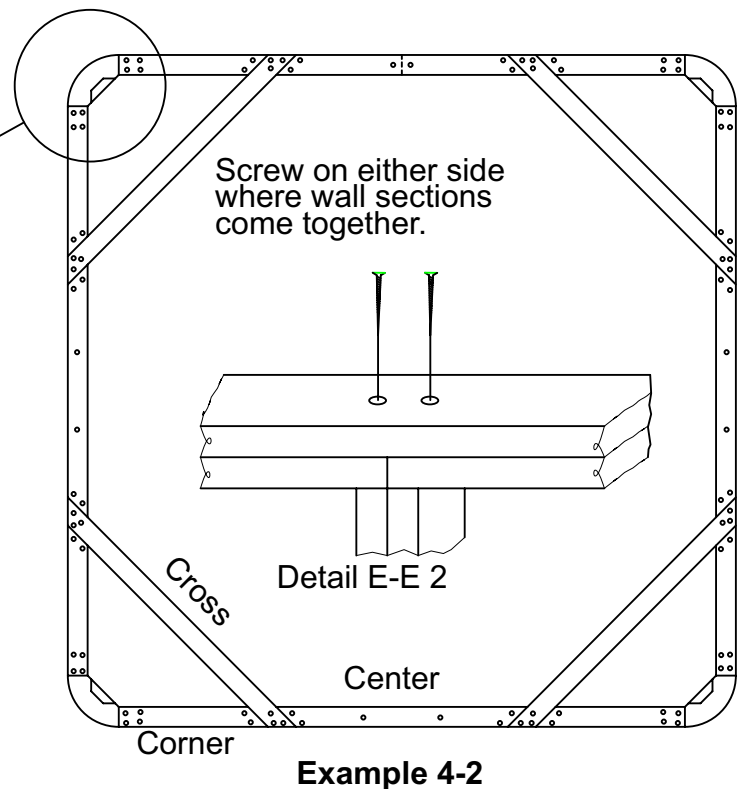
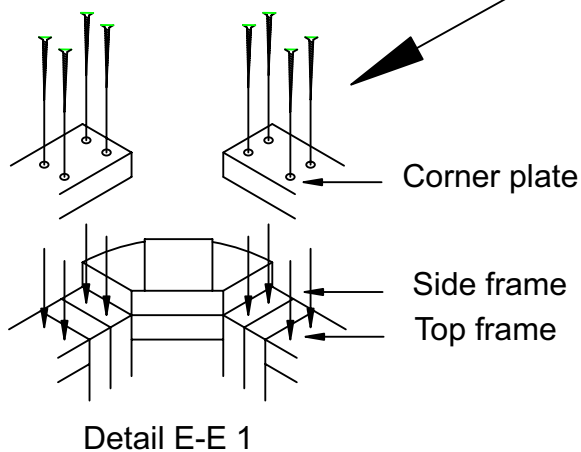

## Step 7

Place the 2x2 wall blocks on the top plate as indicated, flush on the inside. The angled cut should face outward. Secure in place with two screws per block. See detail F-F. Measurements are taken from the end of the top plate.

(See Example 5-1)

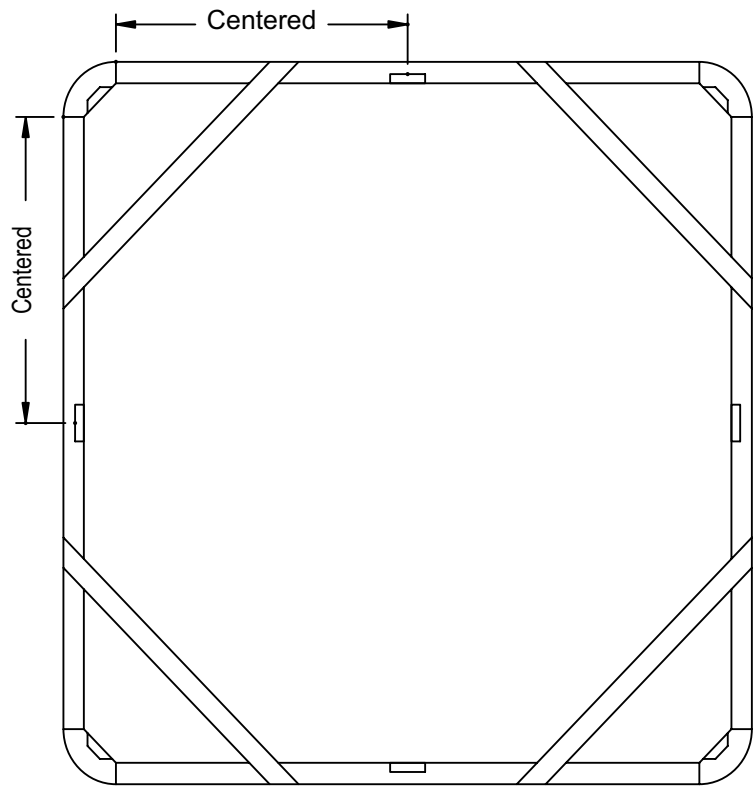

2 Screws per block

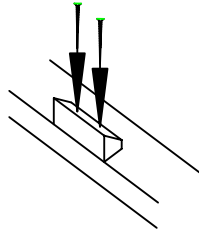

Interior side of wall

Detail F-F

**Example 5-1**

## Step 8

Place the dome box upside down on a level surface. The serial number is on the bottom of the dome box. This should now be facing up. Tap the eight alignment pins 3/4" into the pre-drilled holes in the dome box, leaving 3/4" exposed. Tap four common rafters onto the long sides and secure with two screws each, through the box sides into the rafters. See detail B-B.

(See Example 5-2)

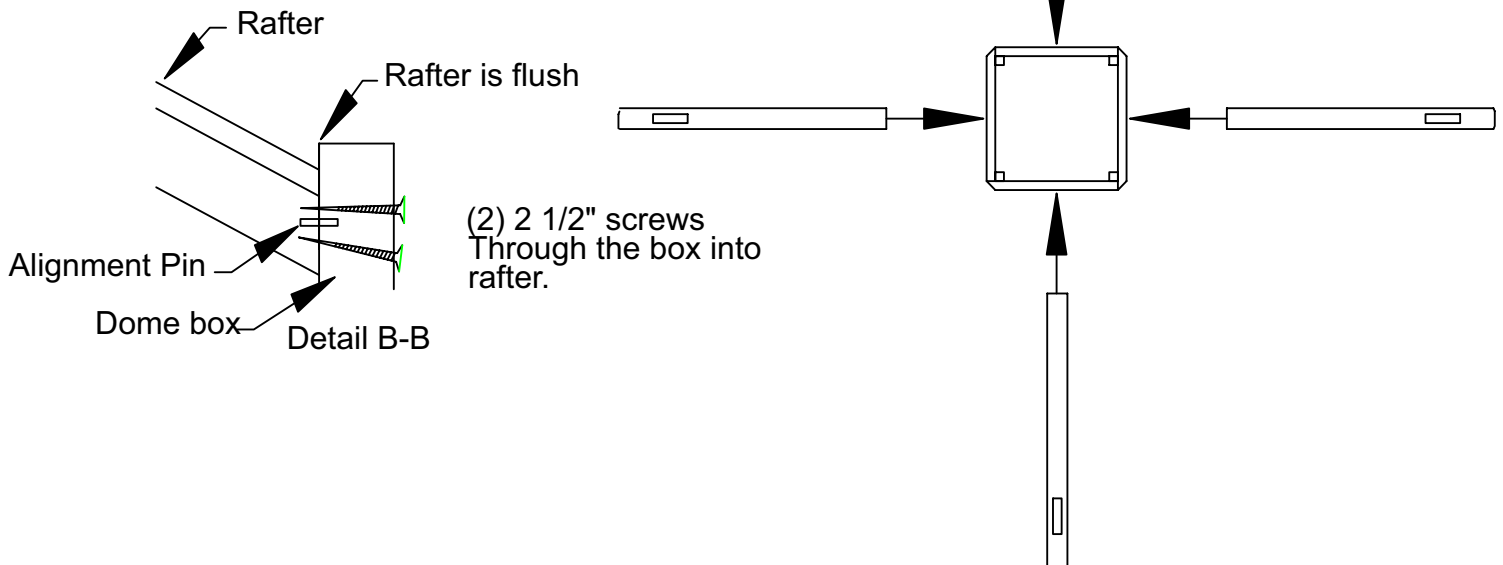

**Example 5-2**

## Step 9

Turn assembled dome box over and slide it onto the top of the gazebo. With one person outside and one inside on a ladder, carefully slide the rafters over the top. The rafters will be centered over the wall blocks. Do not secure at this time. Make sure the box is level. See Detail C-C.

(See Example 6-2)

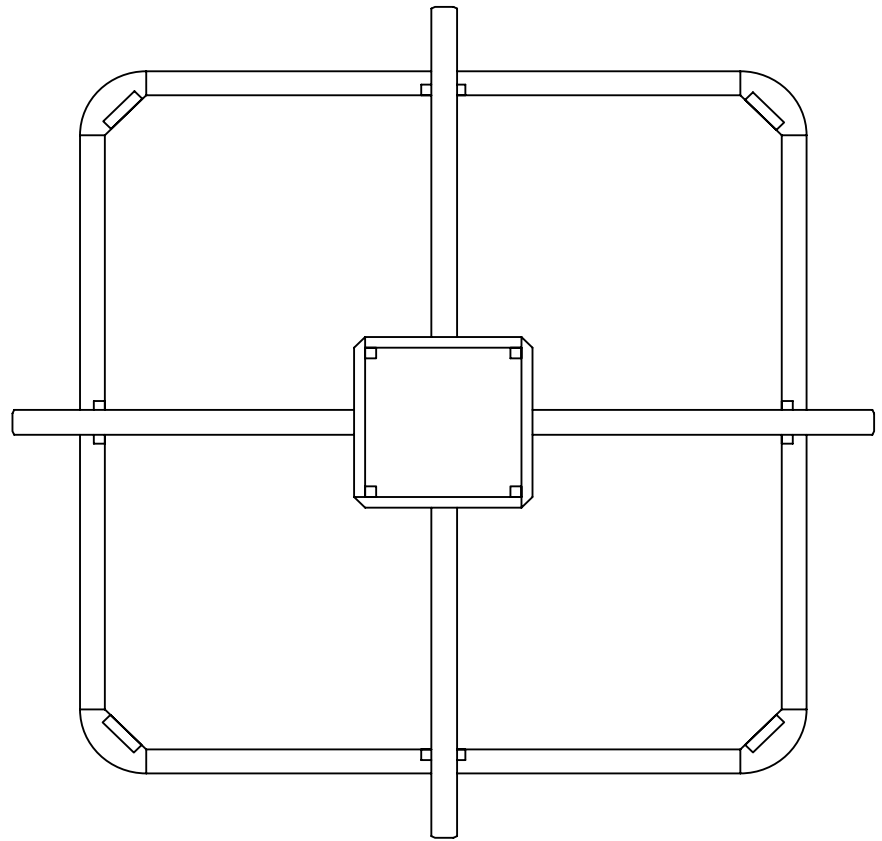
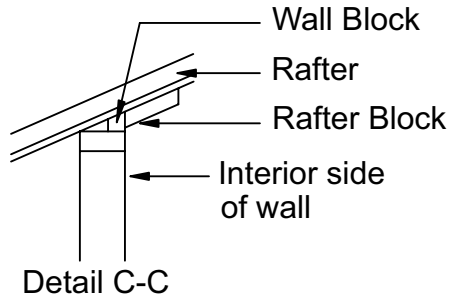

**Example 6-1**

## Step 10

Tap the hip rafters onto the alignment pins in the dome box. See Detail D-D. Secure with one screw. Center rafters over the corner wall block. Do not secure at this time.

(See Example 6-2)

Tap rafter flush against box

Detail D-D

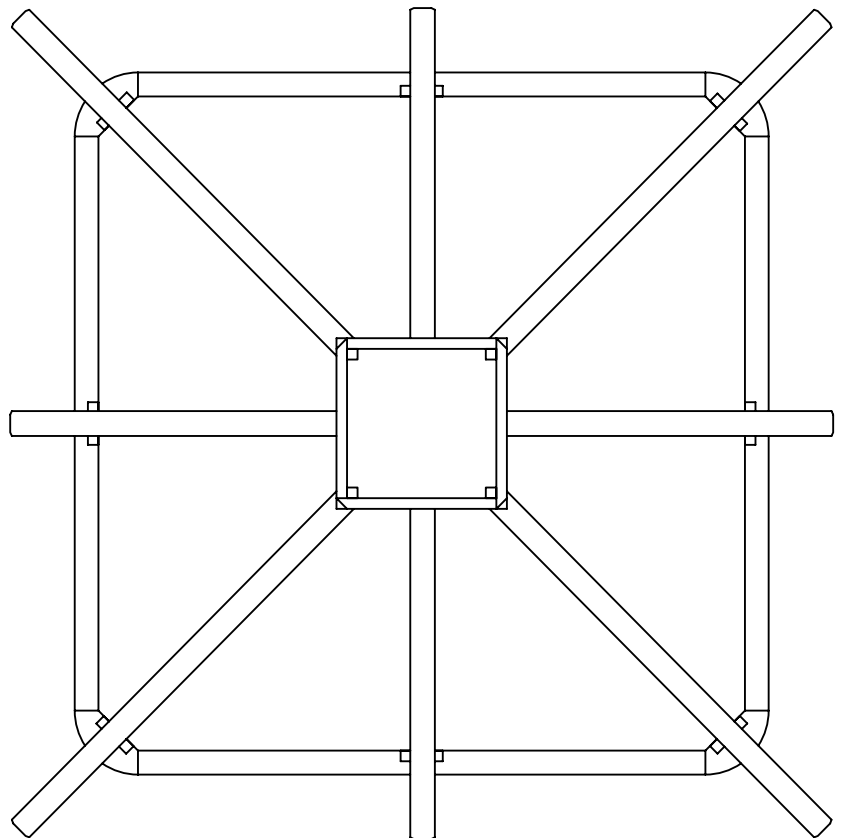
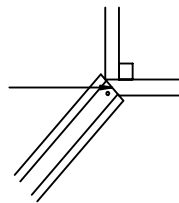

**Example 6-2**

## Step 11

Place dome over the box. Secure with four silver screws and washers. Screws should only be hand tightened to prevent cracking. **DO NOT USE POWER TOOLS.**

(See Example 7-1)

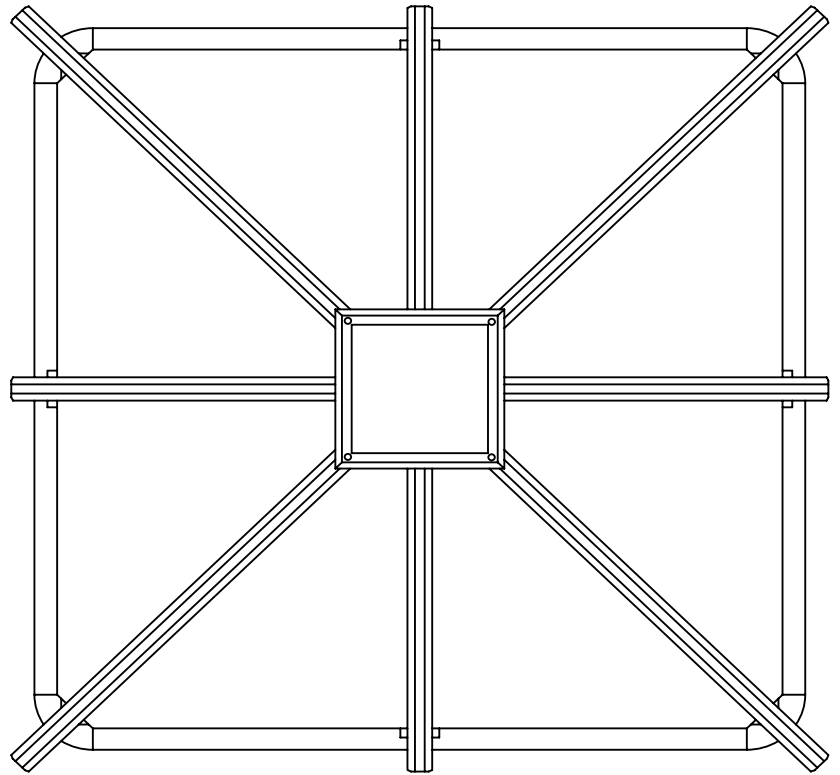

**Example 7-1**

## Step 12

Place angled cut side of the first roof panel on the 1x4 part of the corner rafter, slide the roof panel tight against the dome box and the common rafter. Secure with (6) 2 1/2" screws through the pre-drilled holes in the roof panel into the rafters. Repeat this process for the remaining (7) panels. Note: Start at one corner and work in one direction. Rafters should be unattached for ease of installation.

(See Example 7-2)

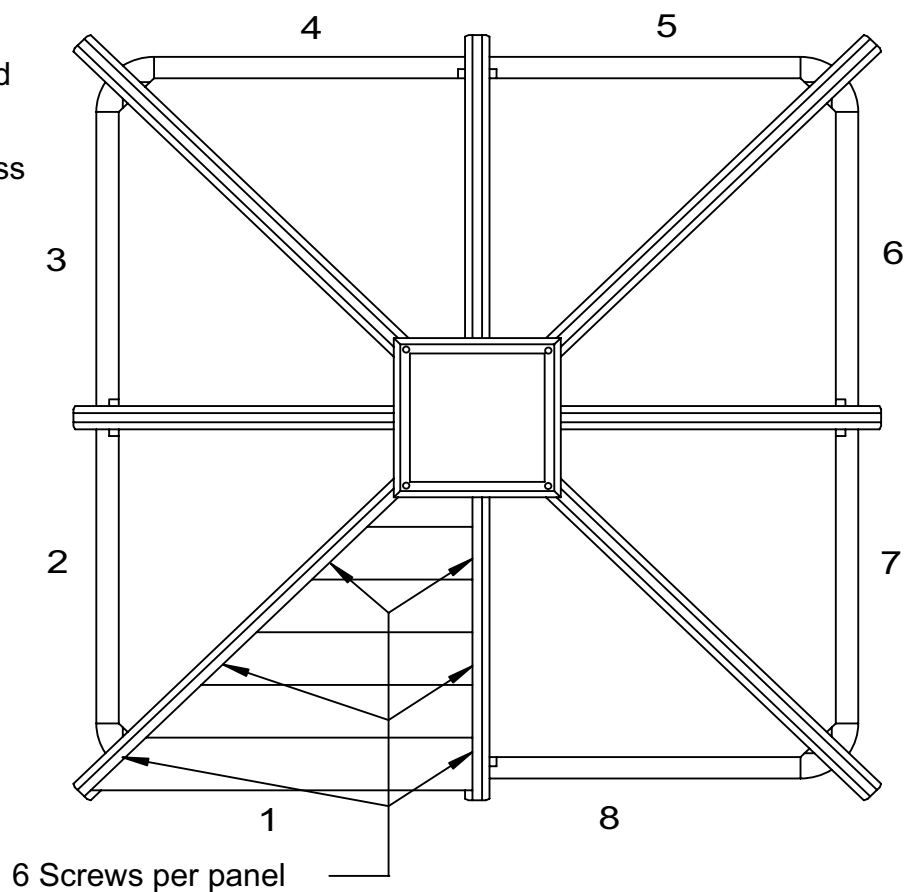

**Example 7-2**

# For Deluxe Metal Roofs- Metal roofs mounted on solid wood.

## Step 13

Fold the hip rafter endcaps as indicated. They have been pre-bent to facilitate the process. Use a square edge to bend straight. Predrill the sides and slide over the end of the hip rafters. Screw into place. (See Example 8-1)

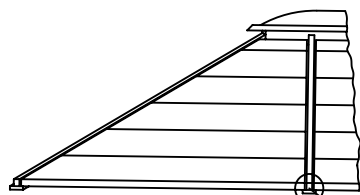
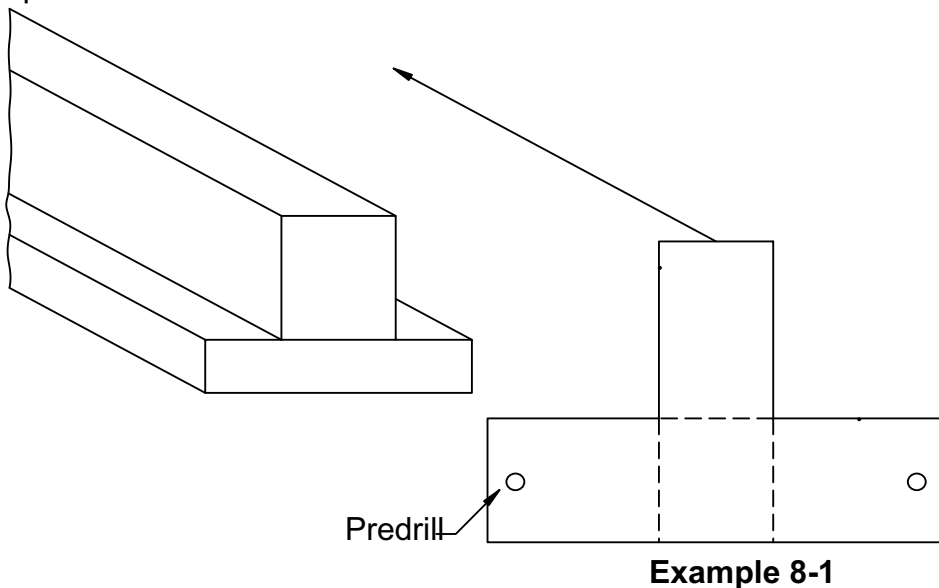

**NOTE:** Fold Weather-Guard flaps over the rafters to ensure a water resistant seal between panels.

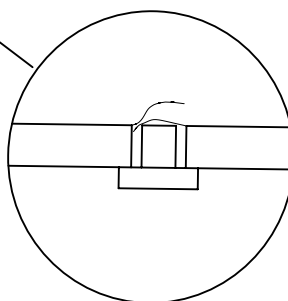

## Step 14

Place all the rafter caps on top of the panels centered over the rafters.  
Secure with (3) colored screws into the rafters.

(See Example 9-1)

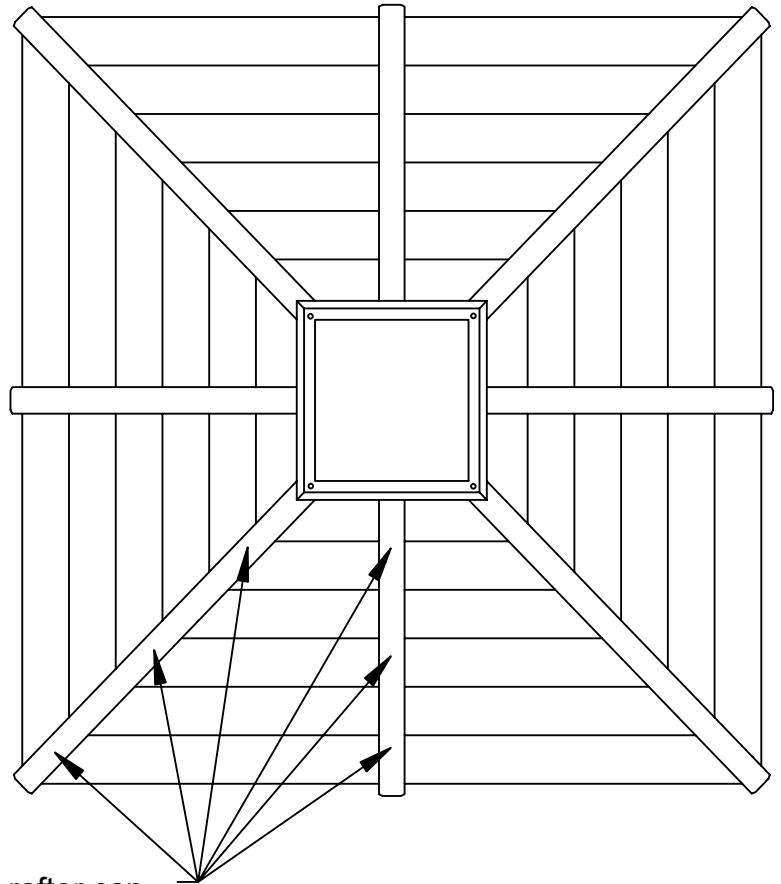

(3) 2 1/2" screws per wood rafter cap

(6) Colored screws per metal rafter cap

**Example 9-1**

## Step 15

From the inside secure the rafter blocks to the wall blocks.

(See Example 9-2)

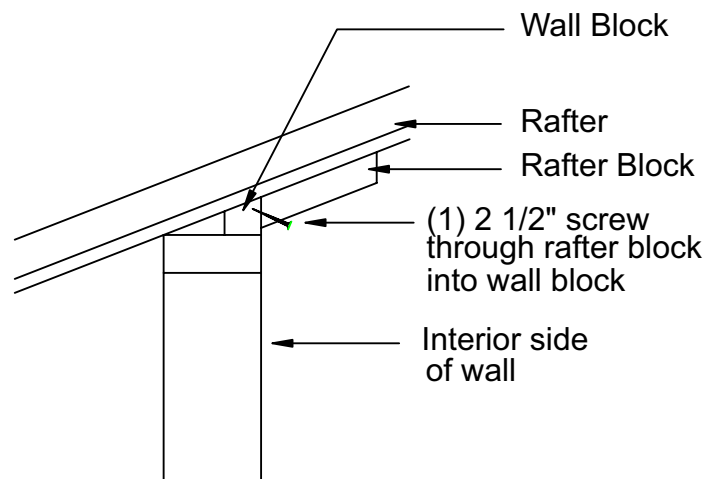

**Example 9-2**

# Gazebo Attachment Instructions

## WOOD DECK ATTACHMENT

When attaching to an existing wood deck, use two 2 1/2" screws per each skirt section

## CONCRETE ATTACHMENT

Drill holes according to the manufacture's recommendation for the concrete anchor system used in this application

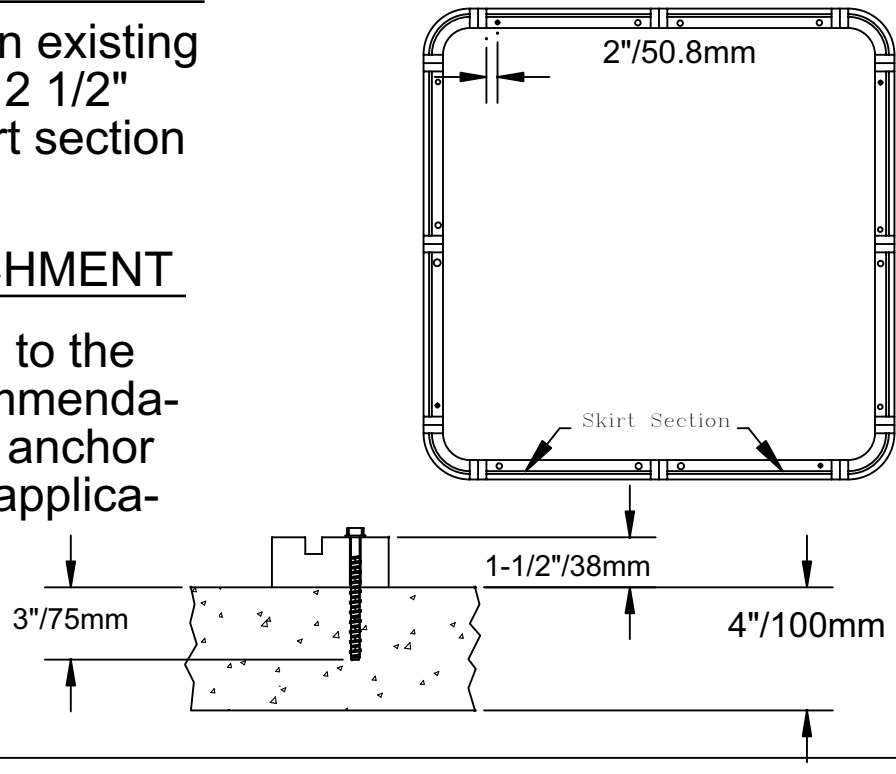

## **Disclosure**

This product is a modular kit, not an assembled structure. It is not designed to be a waterproof or permanent structure. Gazebo Works Too, Inc. is not responsible for assembly and/or mounting, although technical assistance is available during regular business hours. Gazebo Works Too, Inc. is not responsible for damage or injury incurred during assembly. Gazebo Works Too, Inc., reserves the right to make design changes for product improvement.

## **Owner of Documents**

These documents, the ideas and artwork incorporated herein are the property of Gazebo Works Too, Inc., and may not be used in whole or in part, for any reason, without the written consent of an authorized agent of Gazebo Works Too, Inc. Instructions (documents) are provided as an instrument of professional service and courtesy.