



Gazebo-works
Too, Incorporated
"Where Quality Comes First"

P.O. Box 5257
Central Point, OR 97502
www.gazeboworkstoo.com
info@gazeboworkstoo.com

(888) 367-7920 Toll Free
(541) 664-2000
(541) 664-6189 Fax

Customer Service
Monday - Friday
8:00 AM - 5:00 PM PST

Sitting Bay Window

Assembly Instructions

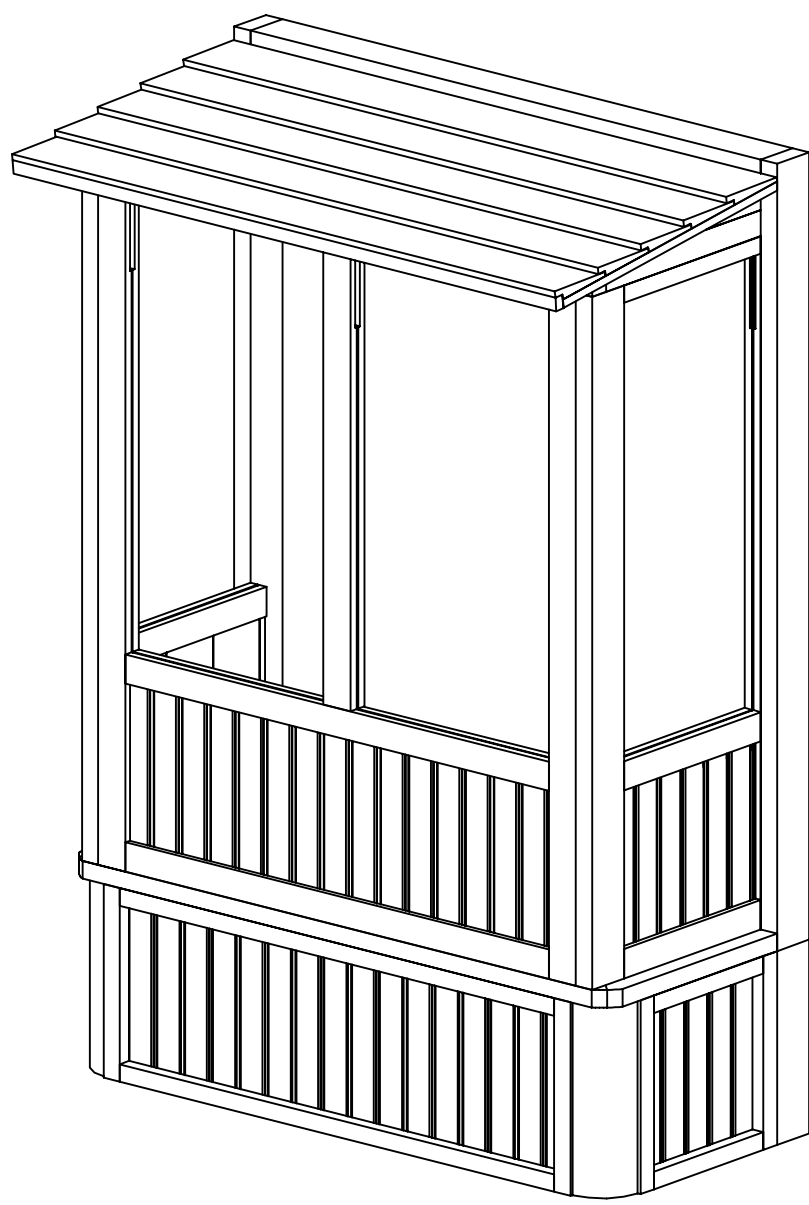

Sitting Bay Window

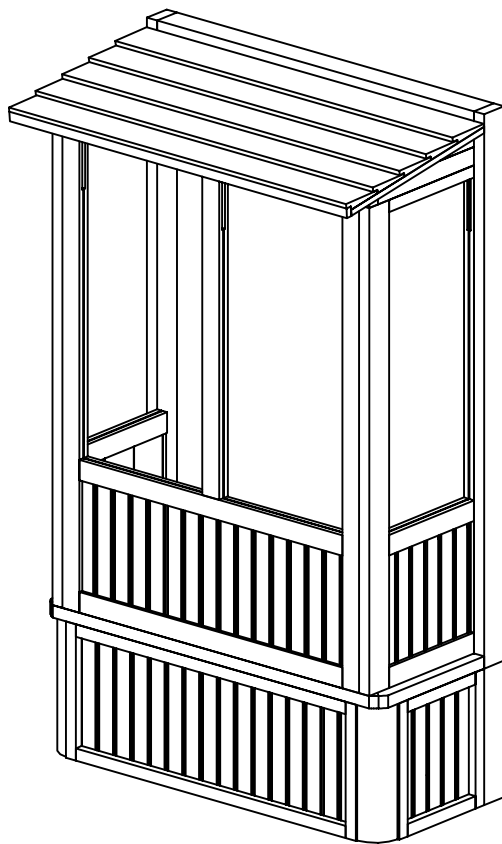
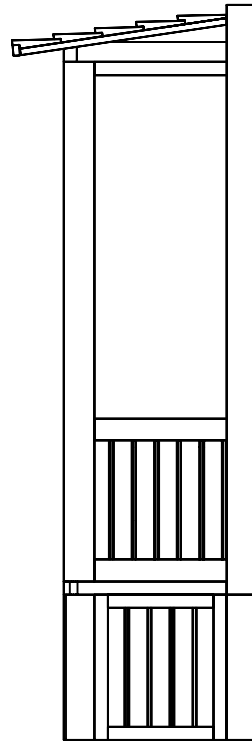
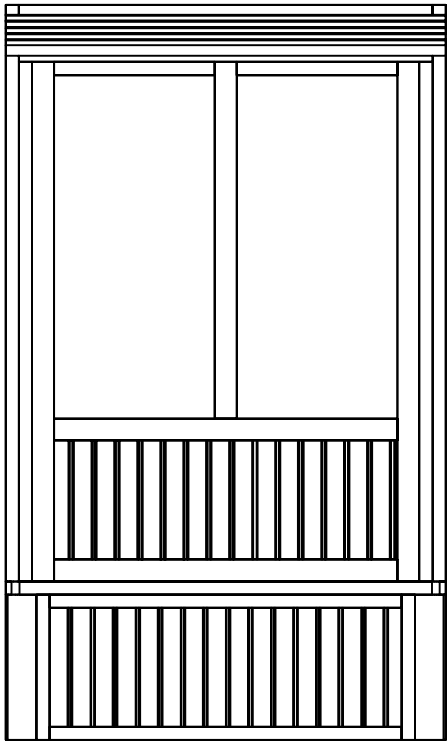

Sitting Bay Window

Manufacturer recommends assembly on a solid flat surface; cement or deck.
Measurements: Height 82"
Width 50"
Depth 27 1/2"

Scalloped Arch



Lid Supports

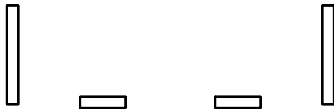

Parts Inventory

Bay Base Assembly
(Bottom View)

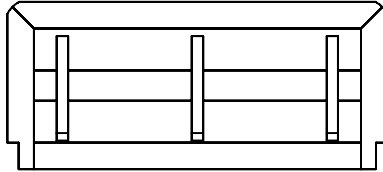

Roof Assembly



Left Side

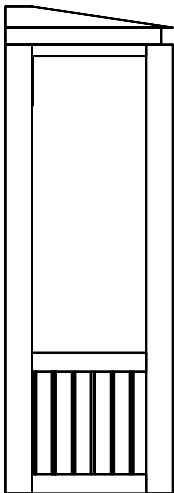

Window Wall

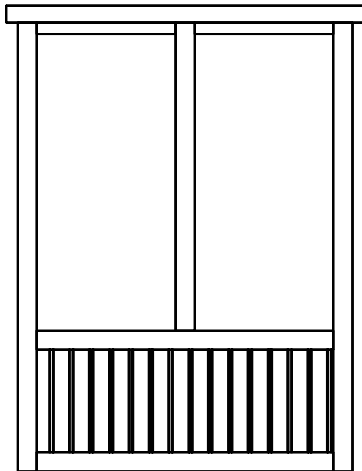

Right Side

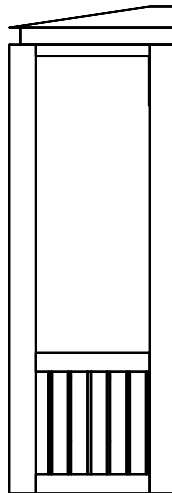

Side Trim for
Metal Roof Option

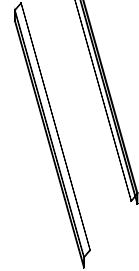

2x4 Wall Framework
Unassembled

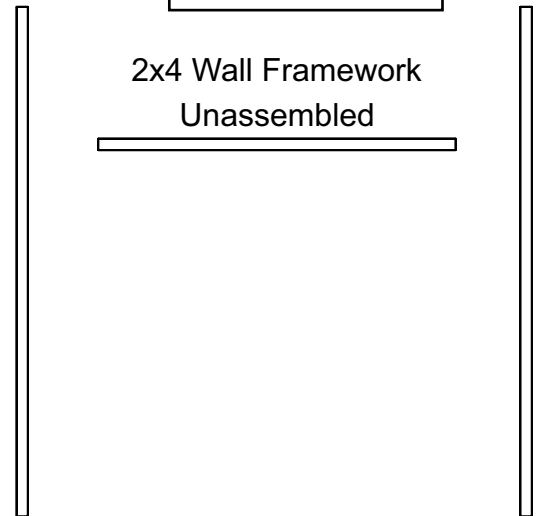

Inner Skirt

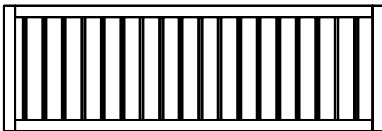

Outer Skirt

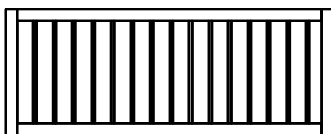

2 Side Skirts

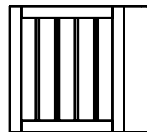

Backrest

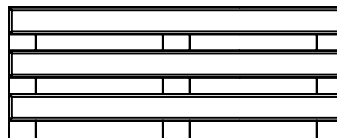

Pack Contents:

1 Hardware Package

1 Pkg. 2 1/2" Zinc Screws
1 Assembly Instructions

Step 1

Determine sitting bay window location(s). A sitting bay window takes the place of any 50" skirt/wall position. Using original assembly instructions, install all skirt sections and door. The following assembly procedure may not show your particular gazebo.

(See Example 2-1)

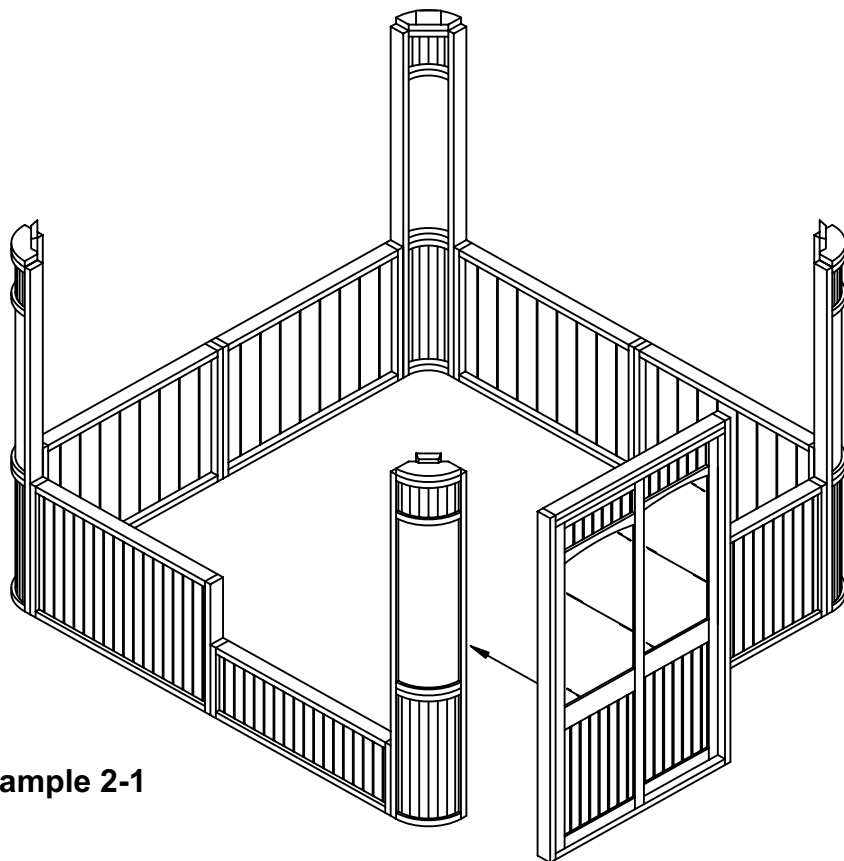

Example 2-1

Step 2

Install walls as required, leaving the sitting bay window(s) for last.

(See Example 2-2)

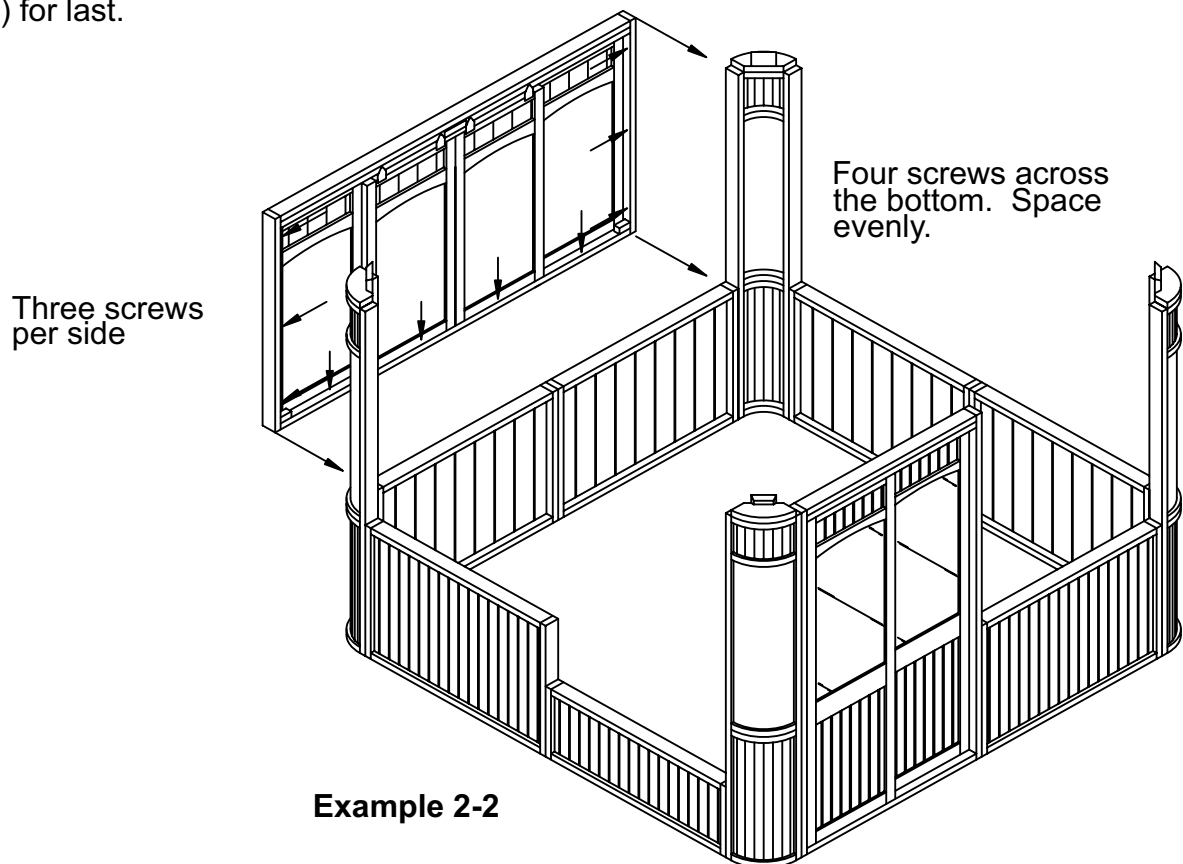

Example 2-2

Step 3

After the last wall is installed, assemble the sitting bay window frame(s).

(See Example 3-1)

Screw each cross rail.

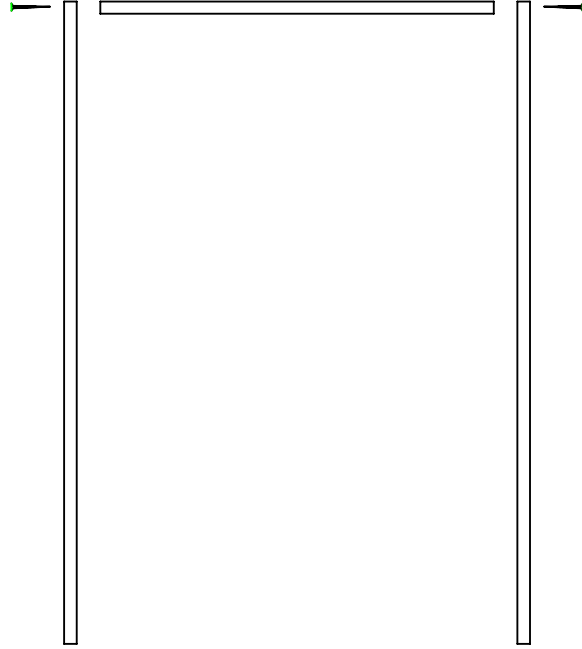

Example 3-1

Step 4

Install sitting bay window frame(s), three screws in each side frame.

(See Example 3-2)

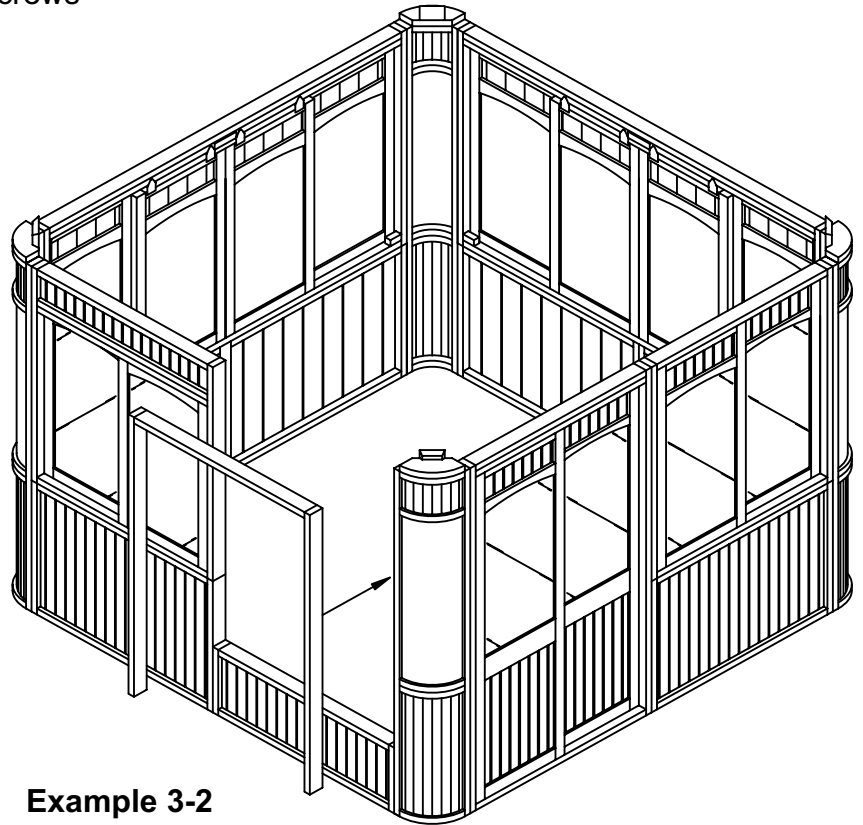

Example 3-2

Step 5

Place the two sides with posts attached against the 2x4 sides of the outer skirt. Screw together as indicated in two places.

(See Example 4-1)

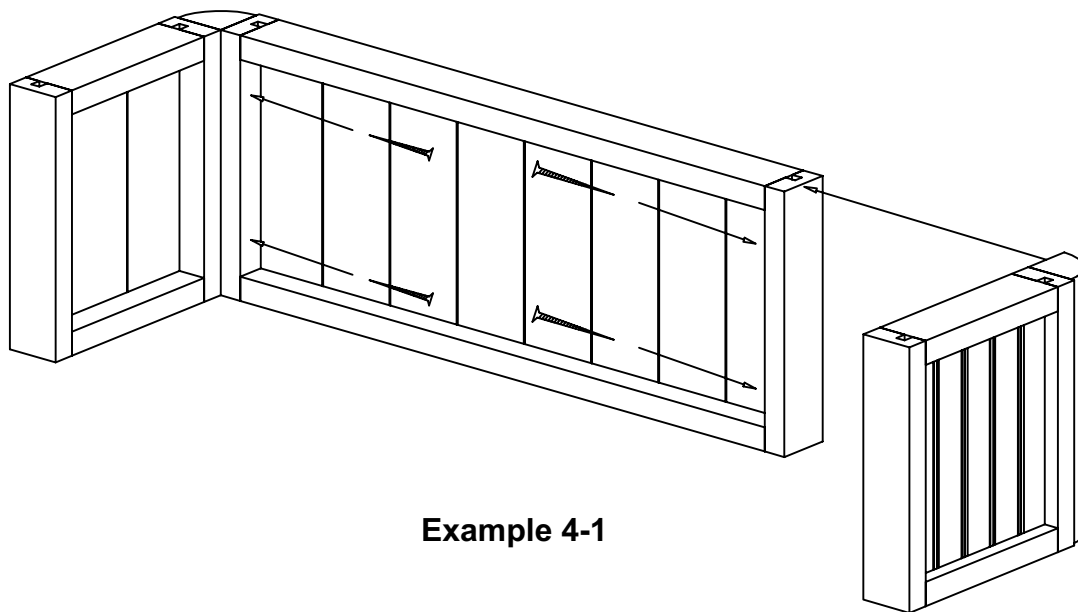

Example 4-1

Step 6

Center the lid supports flush with the skirt side walls and secure with two screws each.

(See Example 4-2)

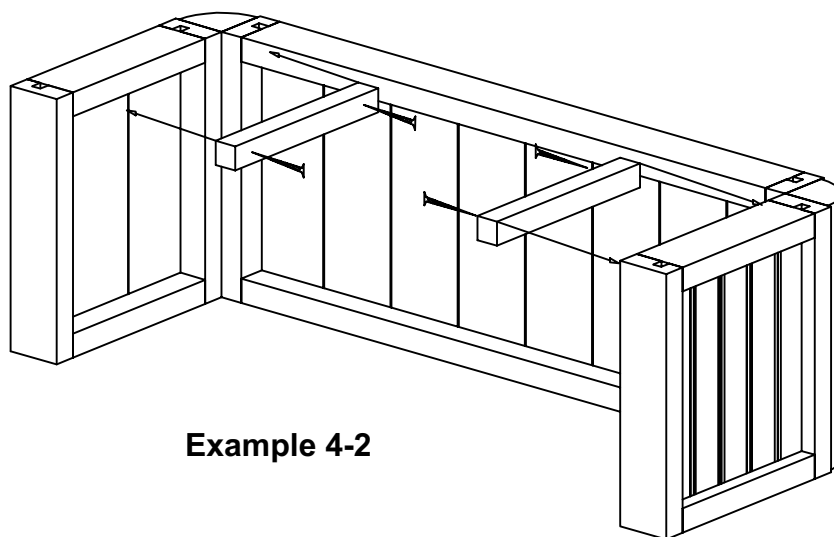

Example 4-2

Step 7

Position the front window wall flush to the front and centered on the seat assembly and screw into position. Screw up from the bottom in three places. Add first one wall and then the other. Secure as indicated.

(See Example 5-1)

4 Screws front side

Note: Front has rounded corners,
Back(inside) is notched.

Example 5-1

2 Screws up into side

3 Screws across front

2 Screws up into side

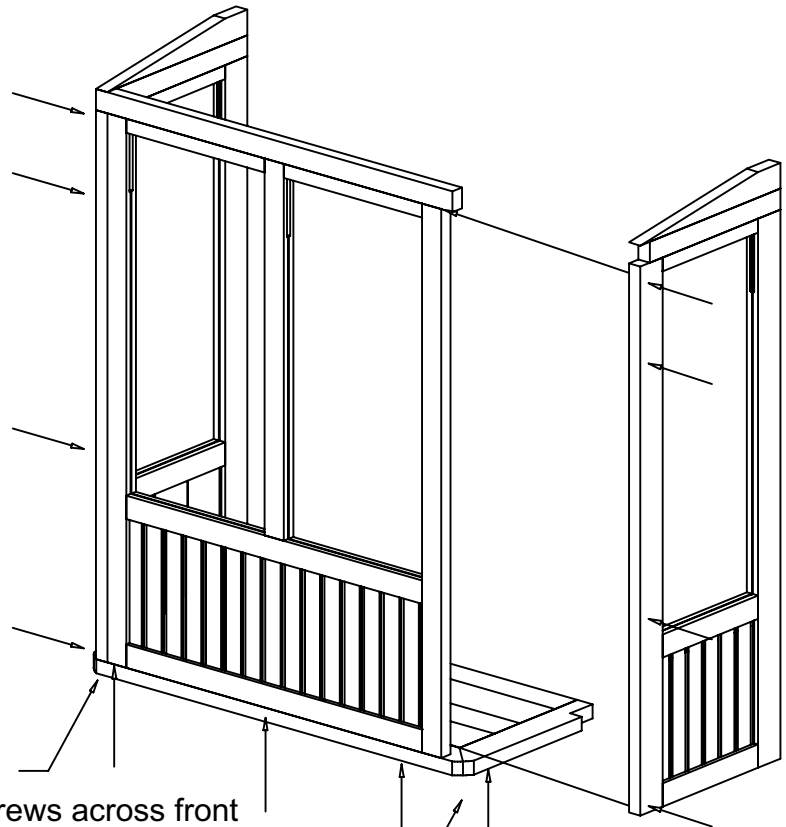

Step 8

Securely attach the base unit to the wall assembly by screwing up through the skirt framework into the frame.

(See Example 5-2)

Example 5-2

8 Screws total

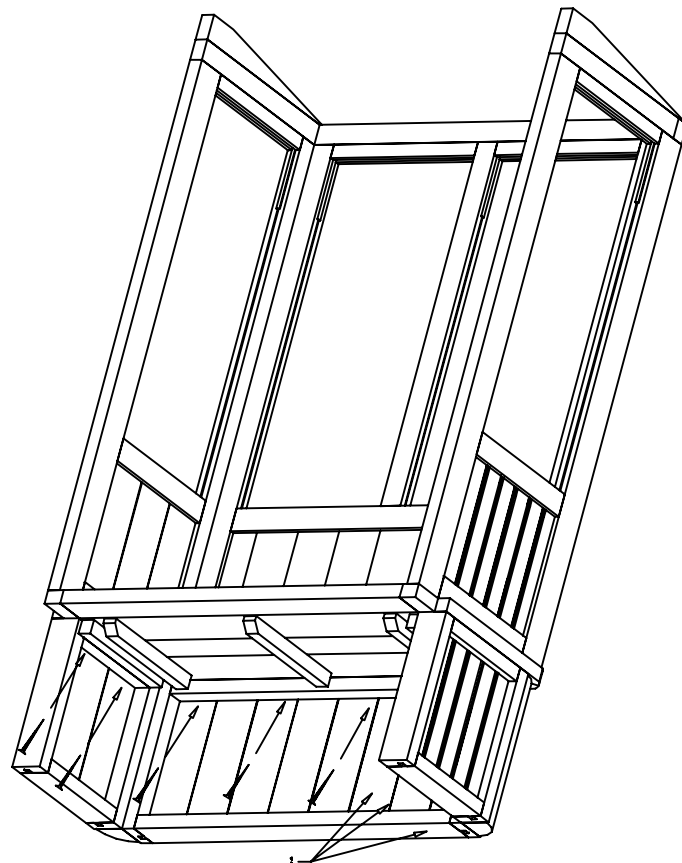

Screw three more places

Step 9

Add the two remaining lid supports to the outside lip of the inner skirt wall.

(See Example 6-1)

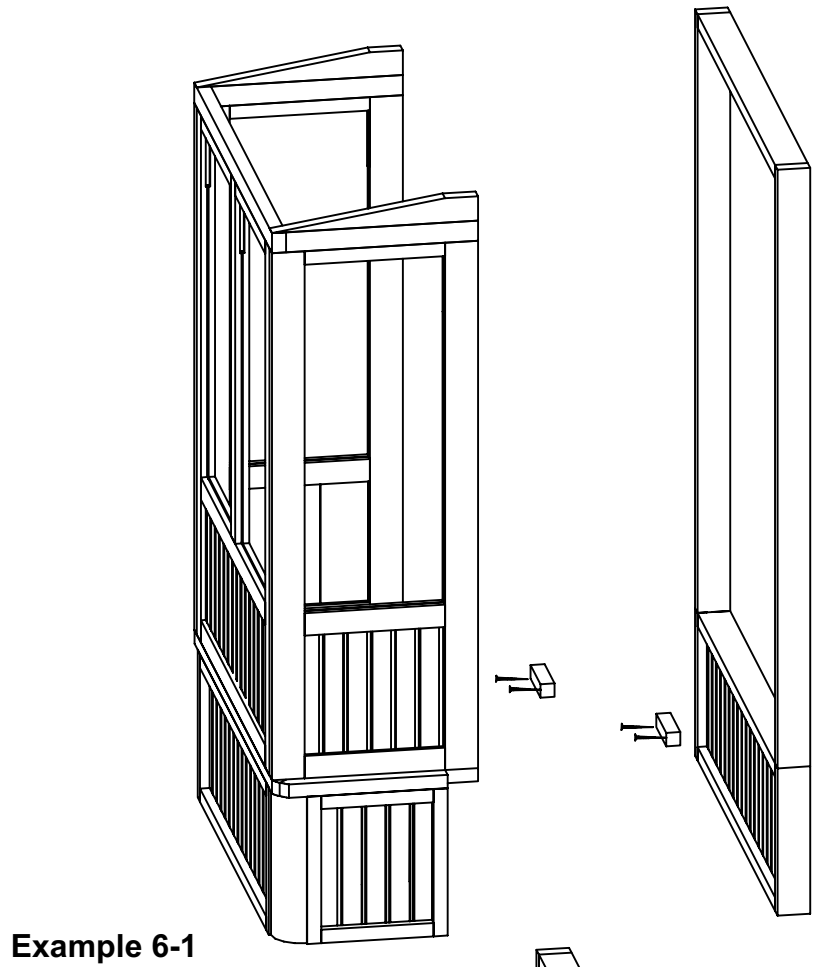

Example 6-1

Step 10

Slide the sitting bay assembly into the opening of the gazebo. Window sides should be flush with the side frame and the base touching the skirt face.

(See Example 6-2)



Example 6-2

Step 11

Make sure that the sitting bay assembly is fully in the window opening, flush to the inside walls and skirt top. Screw in place.

(See Example 7-1)

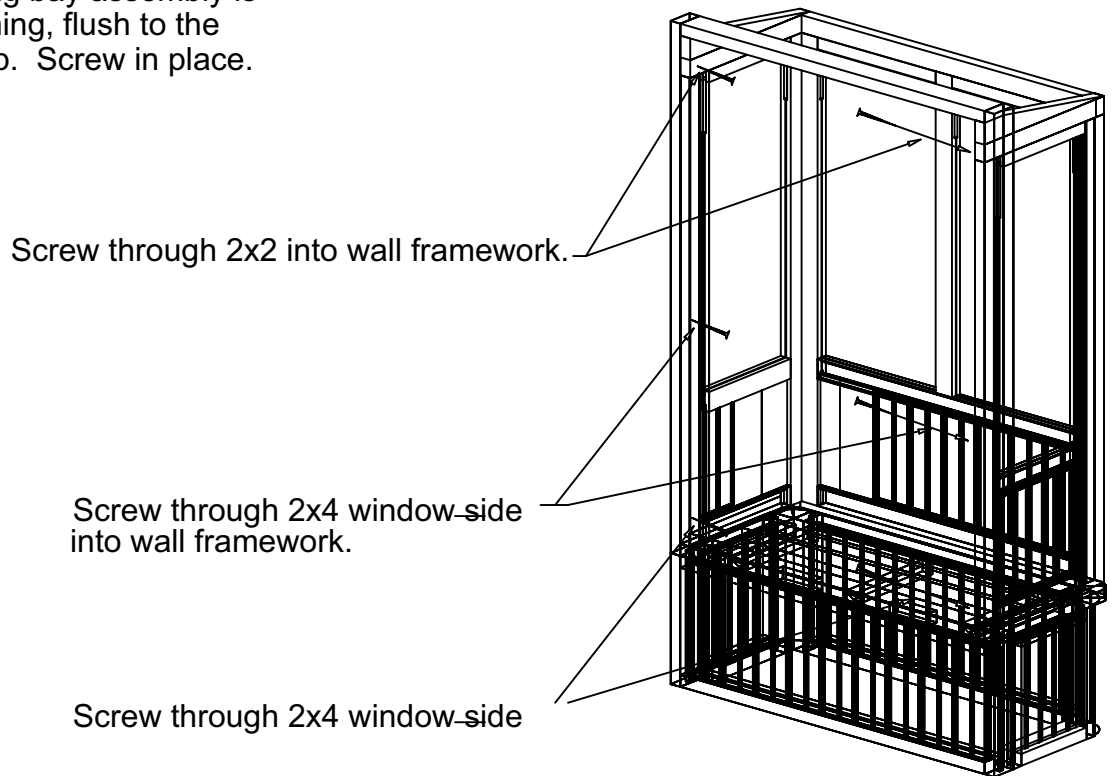

Example 7-1

Step 12

Screw the lower assembly to the short sitting bay skirt.

(See Example 7-2)

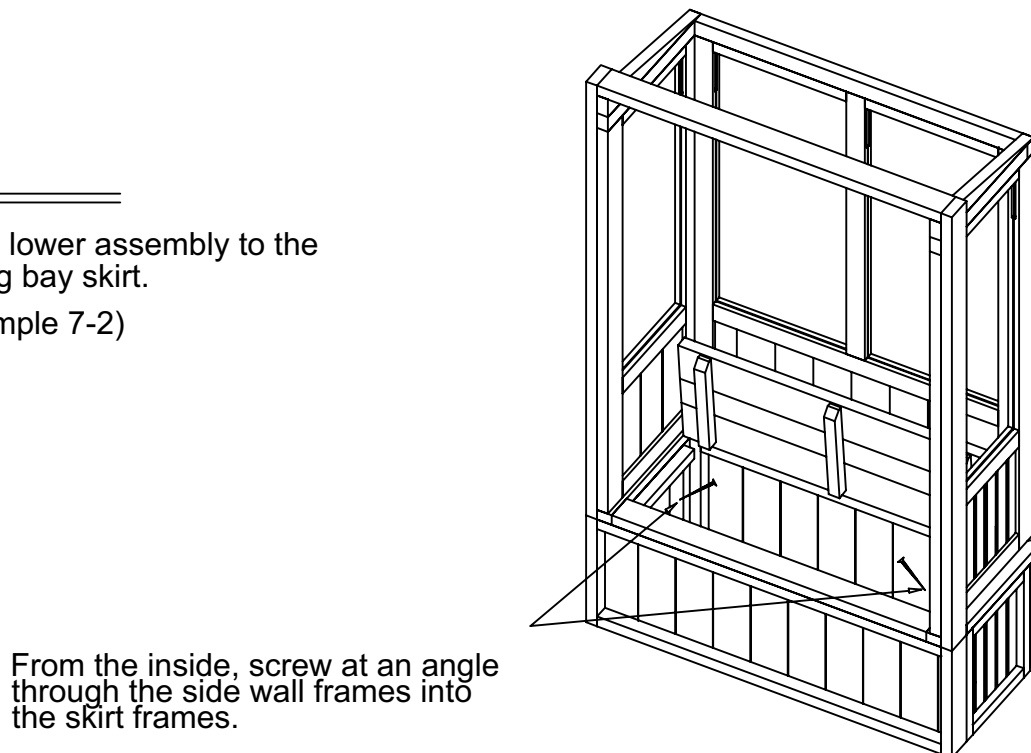

Example 7-2

Step 13

Place the roof assembly on top of the sitting bay window against the gazebo, centered on the framework. Screw down through the roof using the six pre-drilled holes.

(See Example 8-1)

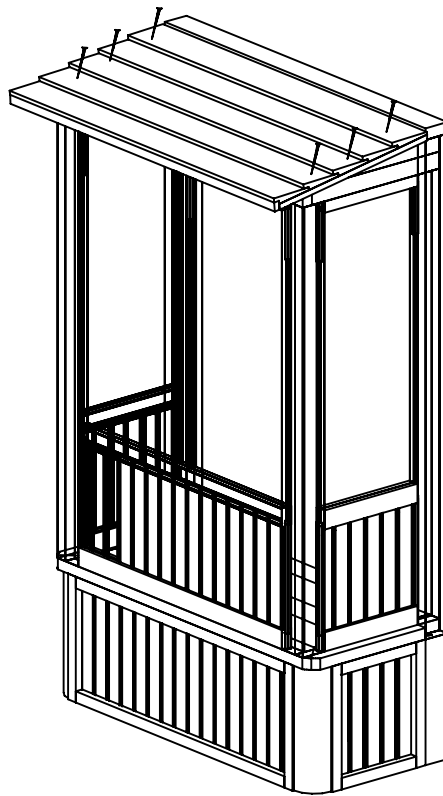

Example 8-1

Step 14

Install the backrest and scalloped arch.

(See Example 8-2)

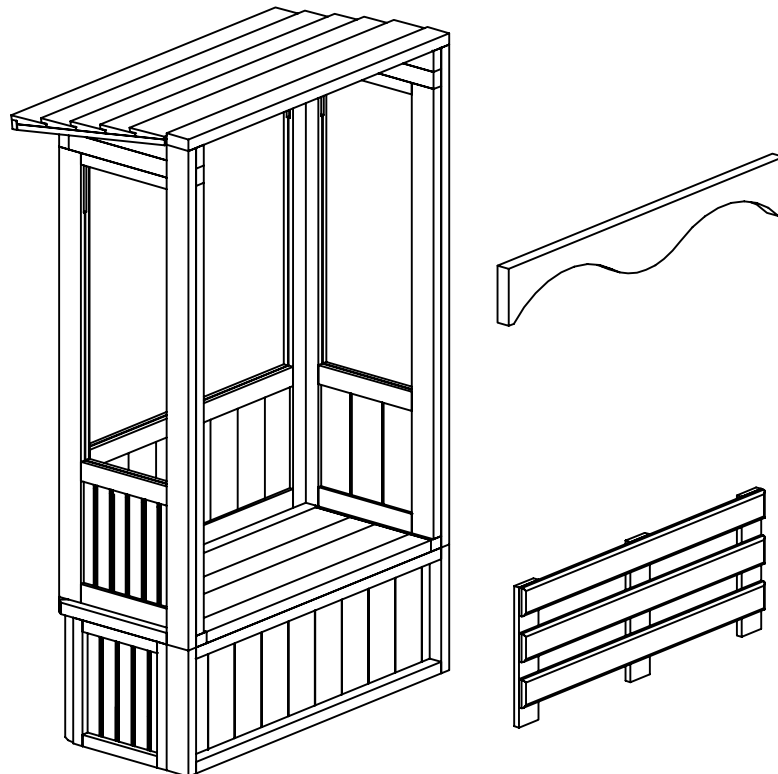

Example 8-2

Step 15

Finish the gazebo installation as shown in the regular assembly instructions.